

Zebra Star - Variation A

© 2016 Maria Sinayskaya
maria@goorigami.com

1

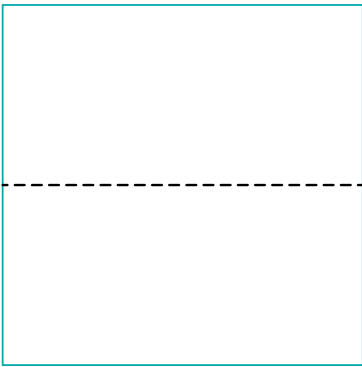

2

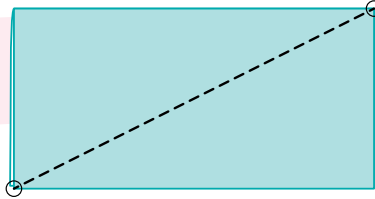

3

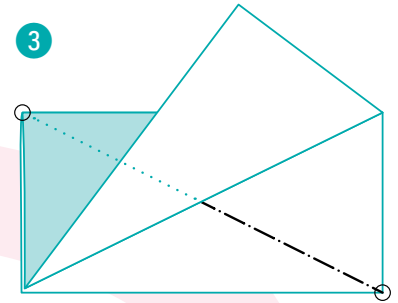

Repeat Step 2 on the other side.

4

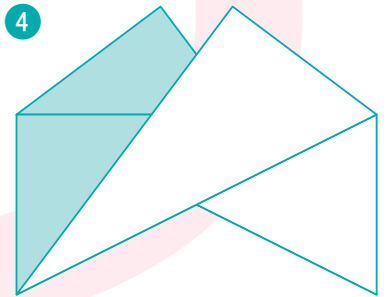

Unfold completely and rotate.

5

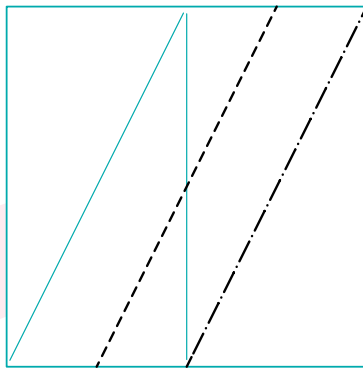

Pleat-fold.

6

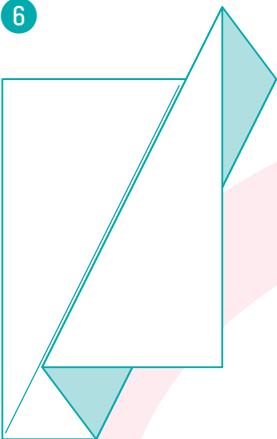

7

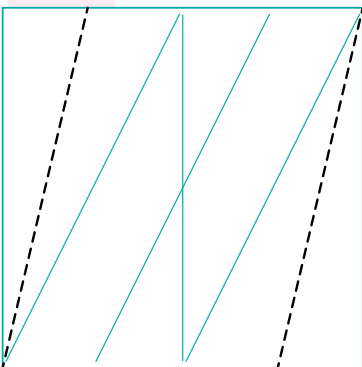

8

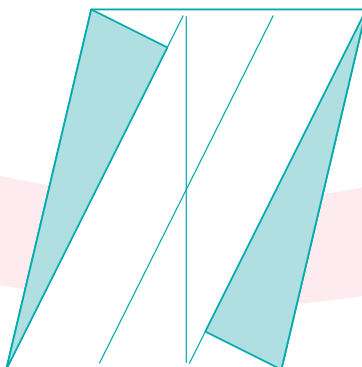

9

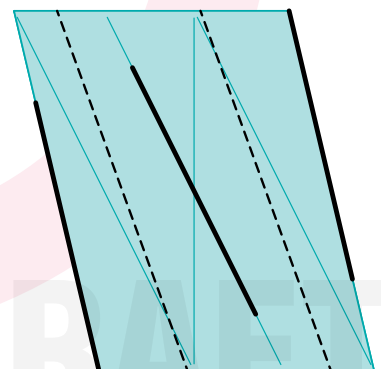

10

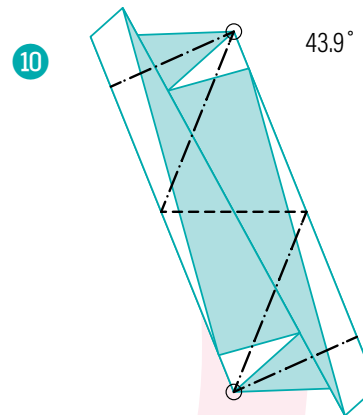

Zebra Star - Variation B

© 2016 Maria Sinayskaya
maria@goorigami.com

1

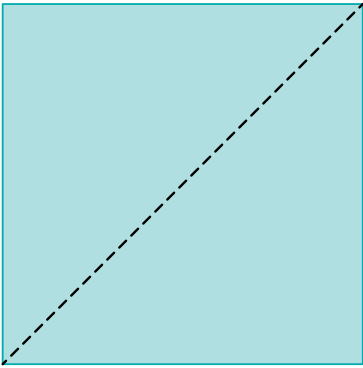

2

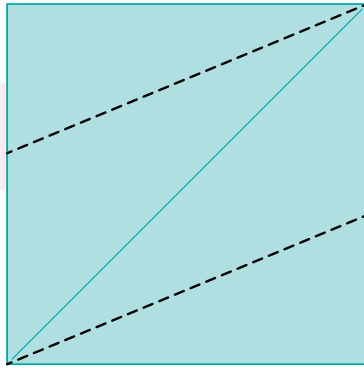

3

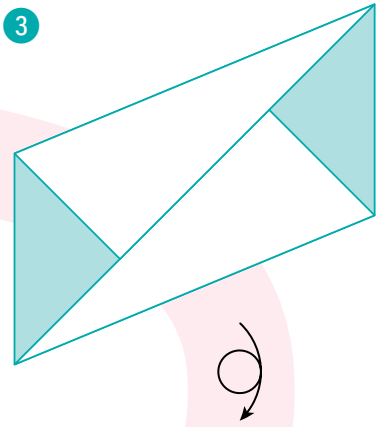

4

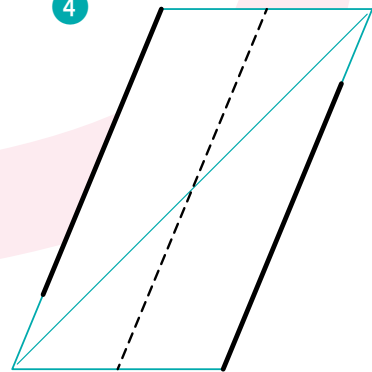

5

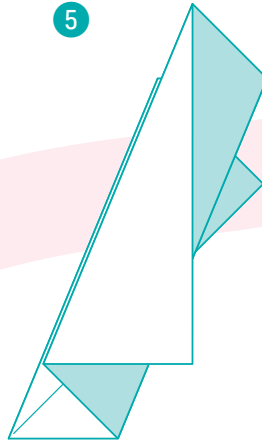

6

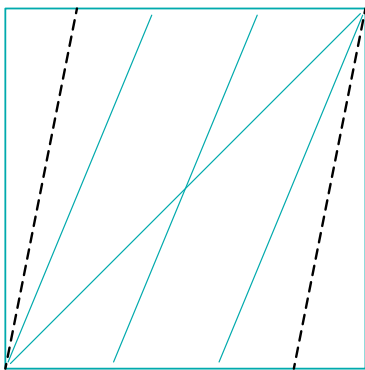

7

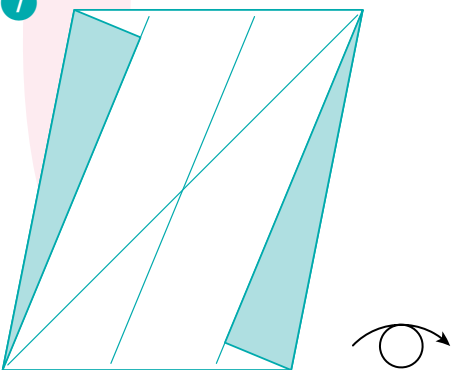

8

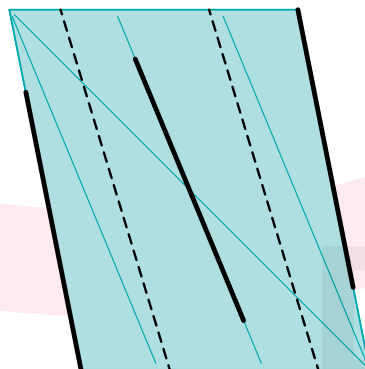

9

